

## Modifications Notices

Limit Switches/Push Buttons/Indicator Lamps/Basic Switches

Issue Date  
June 1, 2020

No. 2020115AE

### Modification Notice for KC marks on Limit Switches, Push Buttons/ Indicator Lamps/ Basic Switches due to compliance with KC requirements

#### [ Effective Date ]

Design changes will be implemented from October to December 2020.

#### [ Applicable Model ]

- Limit Switches
- Push Buttons/Indicator Lamps
- Basic Switches

(For details, refer to the “[ Details of applicable model ]”.)

As there are more than tens of thousands of applicable models, only series names are described in this product news.)



#### [ Reason for change ]

- To respond to KC mark requirements in Korea.

#### [ Change of products specification ]

Unnecessary

#### [ Changes ]

- Addition of KC mark, KC certificate number, Factory Name, and Importer phone number in Korea.
- The display is carried out on product or package.  
(For details, refer to the “[ Details of applicable model ]”.)
- The place to change and add, it is shown in the red frame as a representative example from the next page.

(KC mark)





(KC certificate number)

HU xxxxx-xxxxx  
↑            ↑  
5 digits

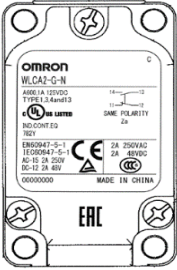
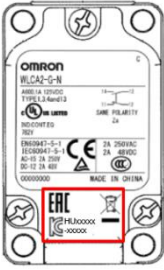
[ Changes: Limit Switches - Representative marking display on the Product ]

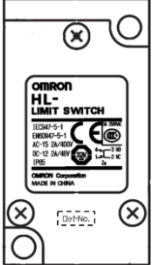
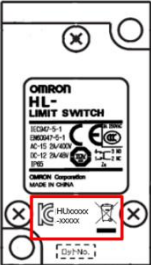
Before change	After change
<p><b>WL/ WL-N series</b></p> <p>UL mark CE mark TUV mark CCC mark EAC mark</p> 	<p><b>WL/ WL-N series</b></p> <p>UL mark CE mark TUV mark CCC mark EAC mark (Position change) KC mark and KC certificate No. (Add)</p> 

Before change	After change
<p><b>HL-5000 series</b></p> <p>CE mark CCC mark TUV mark</p> 	<p><b>HL-5000 Series</b></p> <p>CE mark CCC mark TUV mark KC mark and KC certificate No. (Add)</p> 

Before change	After change
<p><b>D4A-N series</b></p> <p>(Side)</p> 	<p><b>D4A-N series</b></p> <p>(Side) KC mark and KC certificate No. (Add)</p> 

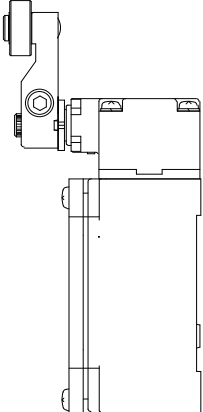
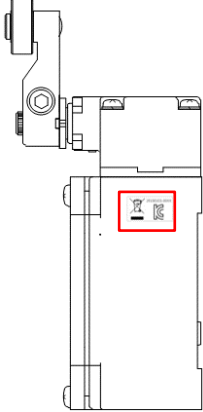
Before change	After change
<p><b>D4B-N Series</b></p> <p>(Side) No display</p> 	<p><b>D4B-N Series</b></p> <p>(Side) KC mark and KC certificate No. (Add)</p> 

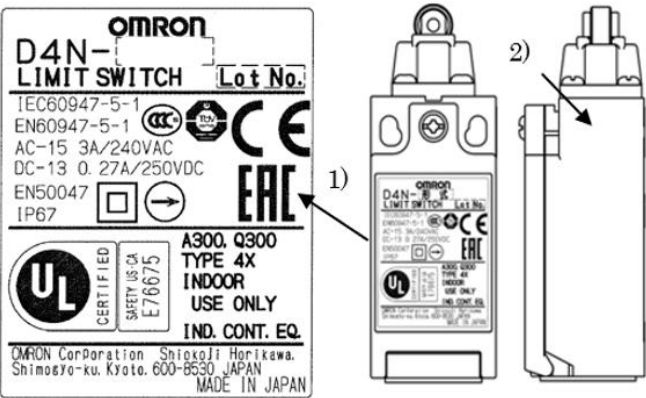
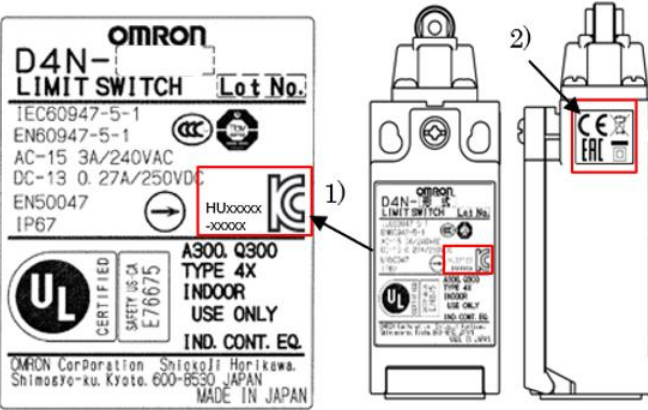

[ Changes: Limit Switches - Representative marking display on the Product ]

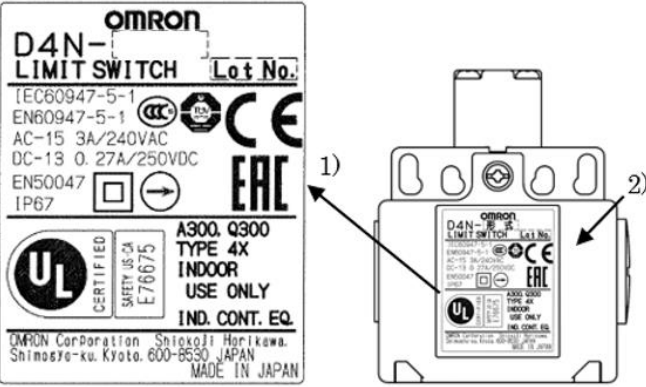
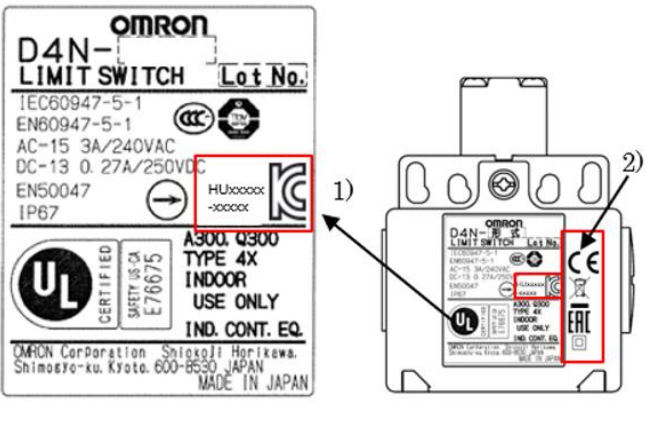

Before change	After change
<p><b>D4N/ D4N-R series; 1 conduit type</b></p> <p>1) (Front)                      CCC mark                      TUV mark                      CE mark                      EAC mark                      Double insulated mark                      Direct opening operation mark                      UL mark</p> <p>2) (Side)                      Nothing</p> 	<p><b>D4N/ D4N-R series; 1 conduit type</b></p> <p>1) (Front)                      CCC mark                      TUV mark                      Direct opening operation mark                      KC mark and KC certificate No. (Add)                      UL mark</p> <p>2) (Side)                      CE mark (Position change)                      EAC mark (Position change)                      Double insulation mark (Position change)</p> 

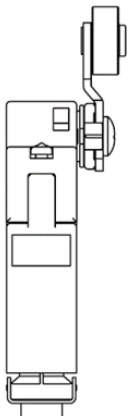
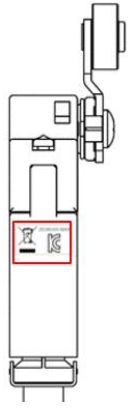

Before change	After change
<p><b>D4N/ D4N-R series; 2 Conduit Types</b></p> <p>1) CCC mark                      TUV mark                      CE mark                      Double insulated mark                      Direct opening operation mark                      EAC mark                      UL mark</p> <p>2) Nothing</p> 	<p><b>D4N/ D4N-R series; 2 Conduit Types</b></p> <p>1) CCC mark                      TUV mark                      Direct opening operation mark                      KC mark and KC certificate No. (Add)                      UL mark</p> <p>2) CE mark (Position change)                      EAC mark (Position change)                      Double insulated mark (Position change)</p> 

[ Changes: Limit Switches - Representative marking display on the Product ]

Before change	After change
<p><b>D4F series</b></p> <p>(Side) No display</p> 	<p><b>D4F series</b></p> <p>(Side) KC mark and KC certificate No. (add)</p> 

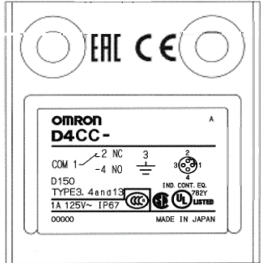

Before change	After change
<p><b>ZE/ ZV/ ZV2 series</b></p> <p>CCC mark</p> 	<p><b>ZE/ ZV/ ZV2 series</b></p> <p>CCC mark KC mark and KC certificate No. (Add)</p> 

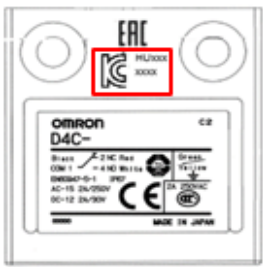

Before change	After change
<p><b>VB series</b></p> <p>CCC mark</p> 	<p><b>VB series</b></p> <p>CCC mark KC mark and KC certificate No. (Add)</p> 

Before change	After change
<p><b>D4CC series</b></p> <p>CCC mark CSA mark UL mark EAC mark CE mark</p> 	<p><b>D4CC series</b></p> <p>CCC mark CSA mark UL mark EAC mark (Position change) CE mark (Position change) KC mark and KC certificate No.(add)</p> 

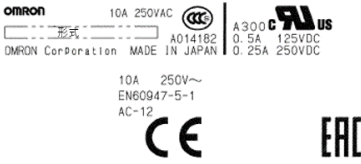
Before change	After change
<p><b>D4C series</b></p> <p>TUV mark CE mark CCC mark EAC mark</p> 	<p><b>D4C series</b></p> <p>TUV mark CE mark CCC mark EAC mark (Position change) KC mark and KC certificate No. (Add)</p> 

**[ Changes: Limit Switches - Representative marking display on the Product ]**

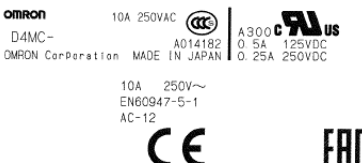
Before change	After change
<p><b>ZC-55 series</b></p> <p>CCC mark UL mark CE mark EAC mark</p> 	<p><b>ZC-55 series</b></p> <p>CCC mark UL mark CE mark EAC mark KC mark and KC certificate No. (Add)</p> 

Before change	After change
<p><b>D4MC series</b></p> <p>CCC mark UL mark CE mark EAC mark</p> 	<p><b>D4MC series</b></p> <p>CCC mark UL mark CE mark EAC mark KC mark and KC certificate No. (Add)</p> 

**[ Changes: Limit Switches - Representative marking display on the Package ]**



Before change	After change
<p><b>Common with each series</b></p> <p>The following series;            WL/ WL-N series, HL-5000 series,            ZE/ ZV/ ZV2 series, XE/XV/XV2 series, VB series,            D4CC series,D4C series, ZC-55 series, D4MC series,            D4E-N series, SHL series</p> <p>Manufacturer name            Manufacturer address            European Importer name            European Importer address</p> <div data-bbox="411 674 751 808" style="text-align: center;"> </div> <div data-bbox="280 987 676 1137" style="text-align: center;"> <p>OMRON Corporation (Manufacturer)            Shiokoji Horikawa, Shimogyo-ku, Kyoto            600-8530, JAPAN            OMRON EUROPE B.V. (Importer in EU)            Wegalaan 67-69, NL-2132 JD Hoofddorp,            THE NETHERLANDS</p> </div>	<p><b>Common with each series</b></p> <p>The following series;            WL/ WL-N series, HL-5000 series,            ZE/ ZV/ ZV2 series, , XE/XV/XV2 series, VB series,            D4CC series,D4C series, ZC-55 series, D4MC series,            D4E-N series, SHL series</p> <p>Manufacturer name            Manufacturer address            European Importer name            European Importer address            Factory name (Add for Korea)            Importer phone number (Add for Korea)</p> <div data-bbox="1114 680 1430 808" style="text-align: center;"> </div> <div data-bbox="890 1016 1286 1151" style="text-align: center;"> <p>OMRON Corporation (Manufacturer)            Shiokoji Horikawa, Shimogyo-ku, Kyoto            600-8530, JAPAN            OMRON EUROPE B.V. (Importer in EU)            Wegalaan 67-69, NL-2132 JD Hoofddorp,            THE NETHERLANDS</p> </div> <div data-bbox="890 1151 1430 1249" style="border: 1px solid red; padding: 5px;"> <p>Dispose in accordance with applicable regulations.            Manufacturer : _____            Phone 02-3483-7722 (Sales in Korea)</p> </div> <div data-bbox="1286 1249 1437 1279" style="text-align: right;"> <p>Factory name</p> </div>



[ Changes: Limit Switches - Representative marking display on the Package ]

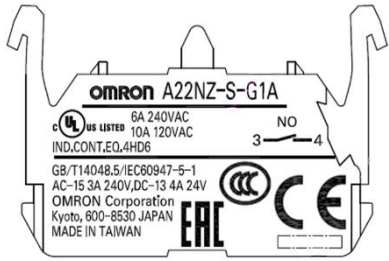
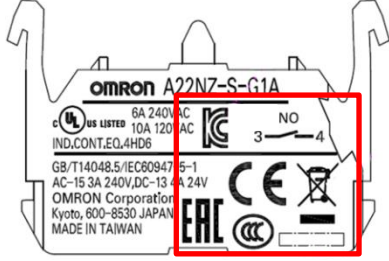

- Representative marking display on the Product ]

Before change	After change
<p><b>A22N/ A30N series</b></p> <p>Contact Block;                      UL mark                      EAC mark                      CCC mark                      CE mark</p> 	<p><b>A22N/ A30N series</b></p> <p>Contact Block;                      UL mark                      KC mark (Add)                      EAC mark                      CE mark (Position change)                      CCC mark (Position change)</p> 







Before change	After change
<p><b>A22 series</b></p> <p>Contact Block;                      (Back)                      Nothing</p> 	<p><b>A22 series</b></p> <p>Contact Block;                      (Back)                      KC mark and                      KC certificate No. (Add)</p> 

Before change	After change
<p><b>A3K/ M2K series</b></p> <p>(Back)                      Nothing</p> <p>A3KJ/ M2KJ                      A3KA/ M2KA</p> 	<p><b>A3K/ M2K series</b></p> <p>(Back)                      A3KJ/ A3KA series                      KC mark and KC certificate No. (Add)</p> <p>A3KJ                                      A3KA</p> 

[ Changes: Push Buttons/ Indicator Lamps





- Representative marking display on the Product ]

<p><b>A3P series</b></p> <p>A3PJ/A3PA series</p> <p>UL mark CSA mark CCC mark</p> <div style="display: flex; justify-content: space-around;"> <div style="text-align: center;"> <p>A3PJ</p>  </div> <div style="text-align: center;"> <p>A3PA</p>  </div> </div>	<p><b>A3P series</b></p> <p>A3PJ/A3PA series</p> <p>UL mark CSA mark CCC mark KC mark and KC certificate No. (Add)</p> <div style="display: flex; justify-content: space-around;"> <div style="text-align: center;"> <p>A3PJ</p>  </div> <div style="text-align: center;"> <p>A3PA</p>  </div> </div>
<p><b>A3PT series</b></p> <p>(Back)</p> <p>Nothing</p> <div style="text-align: center;"> <p>A3PT</p>  </div>	<p><b>A3PT series</b></p> <p>(Back)</p> <p>KC mark and KC certificate No. (Add)</p> <div style="text-align: center;"> <p>A3PT</p>  </div>



[ Changes: Push Buttons/ Indicator Lamps

- Representative marking display on the Package ]



Before change	After change
<p><b>Common with each series</b></p> <p>The following series; A16 series, A165E series, A22N/ A30N series, M22N/ M30N series, A22NE series</p> <p>Manufacturer name Manufacturer address European Importer name European Importer address</p> <div style="text-align: center;">  </div> <div style="text-align: center; margin-top: 20px;"> <p>OMRON Corporation (Manufacturer) Shiokoji Horikawa, Shimogyo-ku, Kyoto 600-8530, JAPAN OMRON EUROPE B.V. (Importer in EU) Wegalaan 67-69, NL-2132 JD Hoofddorp, THE NETHERLANDS</p> </div>	<p><b>Common with each series</b></p> <p>The following series; A16 series, A165E series, A22N/ A30N series, M22N/ M30N series, A22NE series</p> <p>Manufacturer name Manufacturer address European Importer name European Importer address Factory name (Add for Korea) Importer phone number (Add for Korea)</p> <div style="text-align: center;">  </div> <div style="text-align: center; margin-top: 20px;"> <p>OMRON Corporation (Manufacturer) Shiokoji Horikawa, Shimogyo-ku, Kyoto 600-8530, JAPAN OMRON EUROPE B.V. (Importer in EU) Wegalaan 67-69, NL-2132 JD Hoofddorp, THE NETHERLANDS</p> <div style="border: 1px solid red; padding: 5px; display: inline-block; margin-top: 10px;">               Dispose in accordance with applicable regulations.              Manufacturer : _____              Phone 02-3483-7722 (Sales in Korea)         </div> <p style="text-align: right; margin-top: 5px;">Factory name</p> </div>

[ Changes: Push Buttons/ Indicator Lamps



Before change	After change
<p><b>1VAP2 series</b></p> <p>CCC mark</p> 	<p><b>1VAP2 series</b></p> <p>CCC mark KC mark and KC certificate No. (Add)</p> 

**[ Changes: Basic Switches - Representative marking display on the Package ]**

Before change	After change
<p><b>Common with each series</b></p> <p>The following series; Z series, A series, X series, DZ series, TZ series</p> <p>Manufacturer name Manufacturer address European Importer Name European Importer Address</p>  <p>OMRON Corporation (Manufacturer) Shiokoji Horikawa, Shimogyo-ku, Kyoto 600-8530, JAPAN OMRON EUROPE B.V. (Importer in EU) Wegalaan 67-69, NL-2132 JD Hoofddorp, THE NETHERLANDS</p>	<p><b>Common with each series</b></p> <p>The following series; Z series, A series, X series, DZ series, TZ series</p> <p>Manufacturer name Manufacturer address European Importer name European Importer address Factory name (Add for Korea) Importer phone number (Add for Korea)</p>  <p>OMRON Corporation (Manufacturer) Shiokoji Horikawa, Shimogyo-ku, Kyoto 600-8530, JAPAN OMRON EUROPE B.V. (Importer in EU) Wegalaan 67-69, NL-2132 JD Hoofddorp, THE NETHERLANDS</p> <p>Dispose in accordance with applicable regulations. Manufacturer : _____ Phone 02-3483-7722 (Sales in Korea)</p> <p>Factory name</p>

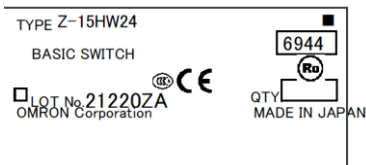
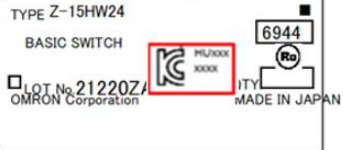

Before change	After change
<p><b>Z series</b></p> <p>In conjunction with [ Common with each series ] of the previous page</p> <p>CCC mark CE mark</p> 	<p><b>Z series</b></p> <p>In conjunction with [ Common with each series ] of the previous page</p> <p>KC mark and KC certificate No. (Add) CCC mark (Delete*) CE mark (Delete*)</p>  <p>(*): There is it on the product.</p>

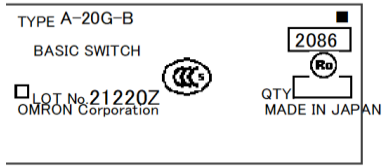
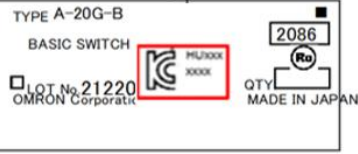
**[ Changes: Basic Switches - Representative marking display on the Package ]**

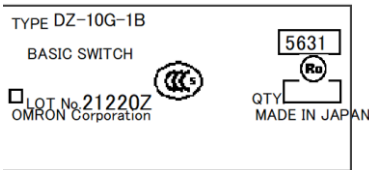
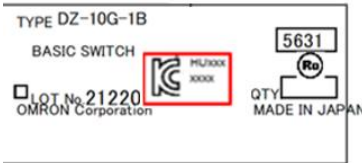
Before change	After change
<p><b>A series</b></p> <p>In conjunction with [ Common with each series ] of the previous page CCC mark</p> 	<p><b>A series</b></p> <p>In conjunction with [ Common with each series ] of the previous page KC mark and KC certificate No. (Add) CCC mark (Delete*)</p>  <p>(*): There is it on the product.</p>

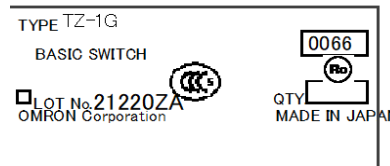
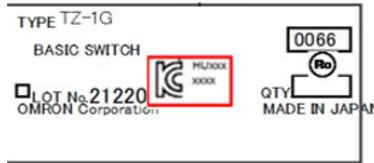
Before change	After change
<p><b>DZ series</b></p> <p>In conjunction with [ Common with each series ] of the previous page CCC mark</p> 	<p><b>DZ series</b></p> <p>In conjunction with [ Common with each series ] of the previous page KC mark and KC certificate No. (Add) CCC mark (Delete*)</p>  <p>(*): There is it on the product.</p>

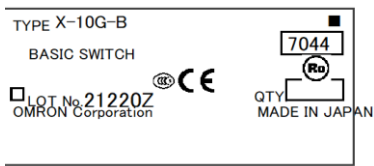
Before change	After change
<p><b>TZ series</b></p> <p>In conjunction with [ Common with each series ] of the previous page CCC mark</p> 	<p><b>TZ series</b></p> <p>In conjunction with [ Common with each series ] of the previous page KC mark and KC certificate No. (Add) CCC mark (Delete*)</p>  <p>(*): There is it on the product.</p>

Before change	After change
<p><b>X series</b></p> <p>In conjunction with [ Common with each series ] of the previous page CCC mark CE mark</p> 	<p><b>X series</b></p> <p>In conjunction with [ Common with each series ] of the previous page CCC mark (Delete*) CE mark (Delete*)</p>  <p>(*): There is it on the product.</p>

[ Details of applicable model ]

The followings are concerned models (series name) in details for design changes. The mark listed with ✓ will be added.

### Limit Switches

Models	Add KC mark and KC certification No.	Add factory name and Importer phone number	Notes including other change except for KC
WL/ WL-N series	✓	✓	
HL-5000 series	✓	✓	
D4A-N series	✓	✓	
D4B-N series	✓	✓	
D4N/ D4N-R series	✓	✓	
D4F series	✓	✓	
ZE/ ZV/ ZV2 series	✓	✓	
VB series	✓	✓	
D4CC series	✓	✓	
D4C series	✓	✓	
ZC-55 series	✓	✓	
D4MC series	✓	✓	
D4E-N series	✓	✓	Indicate KC on package only. Delete CE marking on package (*1)
SHL series	✓	✓	
SH series		✓	
NL series		✓	
TP70 series		✓	
VE series		✓	
D5A series		✓	
D5B series		✓	
D5C series		✓	
D5F series		✓	
XE/XV/XV2 series		✓	

\*1: Delete CE marking on package in order to add KC mark because CE on package is not compulsory.

### Pushbuttons/ Indicator Lamps / Buzzers

Models	Add KC mark and KC certification No.	Add factory name and Importer phone number	Notes including other change except for KC
A22N/ A30N series Switch Unit	✓	✓	
A22N/ A30N series Lighting Unit		✓	
A22 series Switch Unit	✓	✓	
A22 series Lighting Unit		✓	
M22N series Screw terminal type		✓	
M22N series Push-in terminal type		✓	
A3K series	✓	✓	
M2K series		✓	
A3P series	✓	✓	
A3P socket		✓	
A3S/ M2S series		✓	

A3S socket		✓	
M2P series		✓	
M2BJ series		✓	
A16 series	✓	✓	Indicate KC on package only. Delete CE marking on package (*1)
A165E series	✓	✓	
M16 series		✓	
LED lamp(SLL,A16 series)		✓	
1VAP2 series	✓	✓	
1ZAP2 series		✓	
A3U/M3U series		✓	
A2A series		✓	
VAT series		✓	
VAP series		✓	
VAQ series		✓	
XAP series		✓	
ZAP series		✓	
ZAQ series		✓	

\*1: Delete CE marking on package in order to add KC mark because CE on package is not compulsory.

**Basic Switches**

Models	Add KC mark and KC certification No.	Add factory name and Importer phone number	Notes including other change except for KC
Z series	✓	✓	Indicate KC on package only. Delete CCC and CE marking on package (*1)
A series	✓	✓	Indicate KC on package only. Delete CCC on package (*1)
DZ series	✓	✓	
TZ series	✓	✓	
X series		✓	Delete CCC and CE marking on package (*1)

\*1: Delete CCC and CE marking on package in order to add KC mark because CE on package is not compulsory.

Specifications in this product news are as of the issue date and are subject to change without notice.  
Only main changes in specifications are described in this document. Please be sure to read the relevant catalogs, datasheets, product specifications, instructions, and manuals for precautions and necessary information when using products.